







LIBOR NEW

A		C		E		G					
	4 x		12x		4x		1x				
B		D		F							
	8x		4x		4x						

①

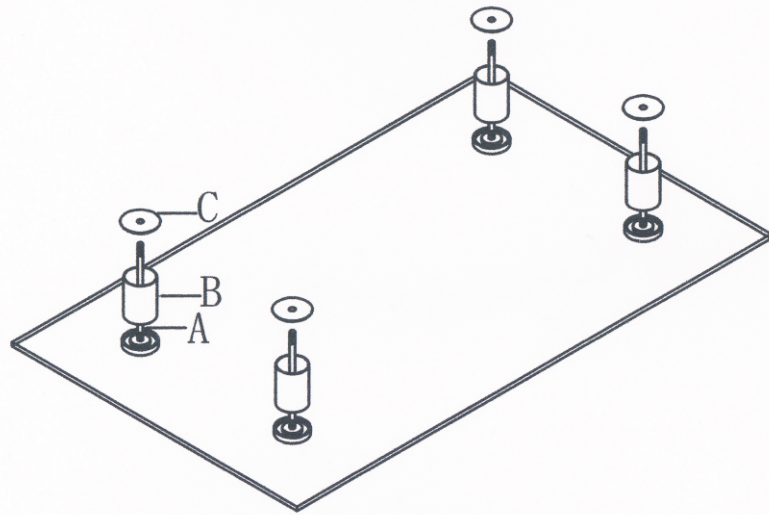

②

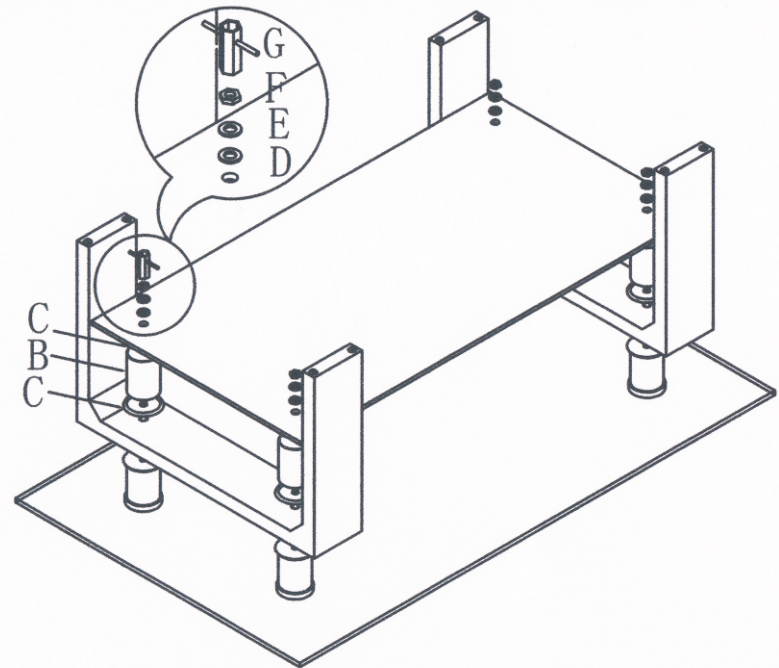

③

